

---

## Vereinswertung 8. Oberlausitz Cup

*Radibor 25.03.2006*

---

<u>Verein</u>	<u>Teiln.</u>	<u>1. Platz</u>	<u>2. Platz</u>	<u>3. Platz</u>	<u>Kampflos</u>	<u>Gesamt</u>
Zwönitzer HSV 1928 Abt. TKD	11	6	3	1	1	47
1. TKD Club Chemnitz	16	3	4	9		39
Taekwondo Wolves Wolmirstedt	8	4	2	2		32
TKD Dojang CHON JI Freiberg	7	5				30
PTSV Hof e.V.	9	4	1	2		29
TKD Gemeinschaft Eilenburg	10	2	3	5		26
Taekwondo - Allkampf - Club Dresden	11		5	4		19
Zentrum für Kampfkünste Gera	5	2	1	2		17
Taekwondo Dojang Bautzen e.V	6	1	3	1	1	17
SV Bad Düben, Abt. Taekwondo	8	2	1	1		16
TSV Rackwitz e.V., Abt. TKD	5	1	3	1		16
SG Nickelhütte Aue Abt. TKD	4	1	3			15
TKD Gemeinschaft Leipzig-Paunsdorf	2	2				12
TKD Verein Seoul Limbach	3	1	1			9
SC Riesa e.V., Abt. TKD	4		2	1	1	8
TKD Club Satori	5		1	3	1	7
Taekwondo YOM CHI e.V.	1		1			3
Kampfsportverein Görlitz e.V.	4			2		2
	119	34	34	34	4	

---

# Einzelergebnisse 8. Oberlausitz Cup

Radibor 25.03.2006

Seite 1 von 2

Klasse	1. Platz	2. Platz	3. Plätze	
H 62- 1	Loebert, Michael Zwönitz	Menzel, Andreas Dresden		
H 67- 1	Hilscher, Danny Wolmirstedt	Dame, Ken Dresden	Dietrich, Tobias Dresden	Waury, Matthias Dresden
H 72- 1	Borchert, Erik Freiberg	Schaupp, Thomas Chemnitz	Herrmann, Daniel Eilenburg	Gränitz, Benny Chemnitz
H 72- 2	Schönfeld, Nico Chemnitz	Harloff, Ronny Chemnitz	Morbitzer, Conrad Dresden	
H 78- 1	Kremler, Thomas Rackwitz	Niepert, Maik Bautzen	Seidel, Torsten Satori Dresden	Stoykov, Nikolay Görlitz
H 78- 2	Rausch, Thomas Chemnitz	Hobrack, Michael Bautzen	Herzig, Kai Dresden	
H 84+ 1	Kuhrau, Sebastian Chemnitz	Möbius, Jan YOM CHI Leipzig	Zinke, Christoph Chemnitz	
H 84+ 2	Dietel, Stephan Freiberg	Meichsner, Bert Zwönitz		
D 51- 1	Gutmann, Franziska Limbach SEOUL	Bartel, Tanja Bautzen	Dörschmann, Monique Eilenburg	
D 59- 1	Höhnisch, Josephine Zwönitz	Mager, Stephanie Nickelhütte Aue		
D 67- 2	Schmidt, Katja Bautzen			
D 72+ 2	Schwarz, Jana Zwönitz	Mager, Nadin Nickelhütte Aue		
D 72+ 1	Lerch, Claudia Zwönitz			
JAM55- 1	Kriebel, Marcel Wolmirstedt	Schubert, Philipp Chemnitz	Seibicke, Erik Wolmirstedt	Berndt, Manuel Zwönitz
JAM59- 2	Wick, Christian Riesa			
JAM63- 1	Nix, Alexander Nickelhütte Aue	Lippert, David Chemnitz	Bauer, Paul Gera	Krause, Christian Gera
JAM68- 2	Sidjeci, Elvis Gera	Richter-Osborne, Hans Rackwitz	Möller, Steven Görlitz	
JAM73- 2	Friedrich, Lukas Leipzig-Paunsdorf	Weigel, Tobias Zwönitz	Peters, Friedemann Bautzen	Lange, Marcel Eilenburg
JAM73- 1	Scholz, Daniel Bad Düben	Langer, Carsten Wolmirstedt	Özkardes, Yakup Hof	Zinke, Stephan Chemnitz
JAM78+ 1	Kaygisiz, Ramazan Hof	Liebold, René Dresden		

# Einzelergebnisse 8. Oberlausitz Cup

Radibor 25.03.2006

Seite 2 von 2

Klasse	1. Platz	2. Platz	3. Plätze	
JAW55- 1	Schwarz, Anja Zwönitz	Striegnitz, Daniela Gera		
JAW55- 2	Werner, Julia Zwönitz	Rößle, Laura Rackwitz	Vornberger, Anne Satori Dresden	
JAW63- 1	Alke, Luise Leipzig-Paunsdorf	Lohwasser, Sabrina Dresden	Antel, Linda Chemnitz	
JBM37- 2	Sebastian, Hugh Satori Dresden			
JBM46- 2	Zeh, Robin Hof	Spranger, Felix Hof	Nguyen, Hai Dang Satori Dresden	
JBM49- 2	Jensky, Martin Gera	Gefrörer, Tim Rackwitz		
JBM57- 2	Rehberg, Dominik Hof	Reinhold, Tino Bad Düben		
JBM65+ 2	Röschke, Martin Bautzen	Wils, Jeffrey Nickelhütte Aue		
JBW44- 2	Gögremis, Mehtap Eilenburg	Sachse, Sophie Eilenburg	Schöne, Sarah Wolmirstedt	Tiefenbach, Julia Hof
JBW53- 2	Heinzig, Sabrina Eilenburg	Schwipper, Stephanie Eilenburg		
JBW61+ 2	Elharchani, Sara Freiberg	Kühne, Anne Riesa	Sucker, Saskia Eilenburg	Müller, Doreen Eilenburg
JBW61+ 1	Stimpel, Julia Wolmirstedt	Ehrlich, Anna Limbach SEOUL		
JCM30- 2	Jänichen, Max Freiberg	Radoi, Kevin Dresden	Zeidler, Martin Bad Düben	
JCM32- 2	Kout, Bastian Hof	Kühne, Tino Riesa	Rößle, Nick Rackwitz	Kühne, Tim Riesa
JCM38- 2	Falkenhagen, Thomas Wolmirstedt	Bruck, Manuel Zwönitz	Tauschke, Sebastian Chemnitz	Beer, Alexander Chemnitz
JCM45- 2	Wunderlich, Jan Bad Düben	Werner, Nico Satori Dresden	Römpler, Maximilian Chemnitz	Kühn, Chris Chemnitz
JCW32- 1	Schwarzbach, Laura Zwönitz	Bierstedt, Lucie Wolmirstedt	Mühlberg, Theresa Chemnitz	
JCW41- 2	Scheibe, Sandy Freiberg	Peti, Sarah Eilenburg		

H 62-

1 8. Oberlausitz Cup

Radibor 25.03.06

Pool Nr.: 2

---

Endkampf

KO

5 10

Menzel, Andreas

Loebert, Michael

Dresden

Zwönitz

234

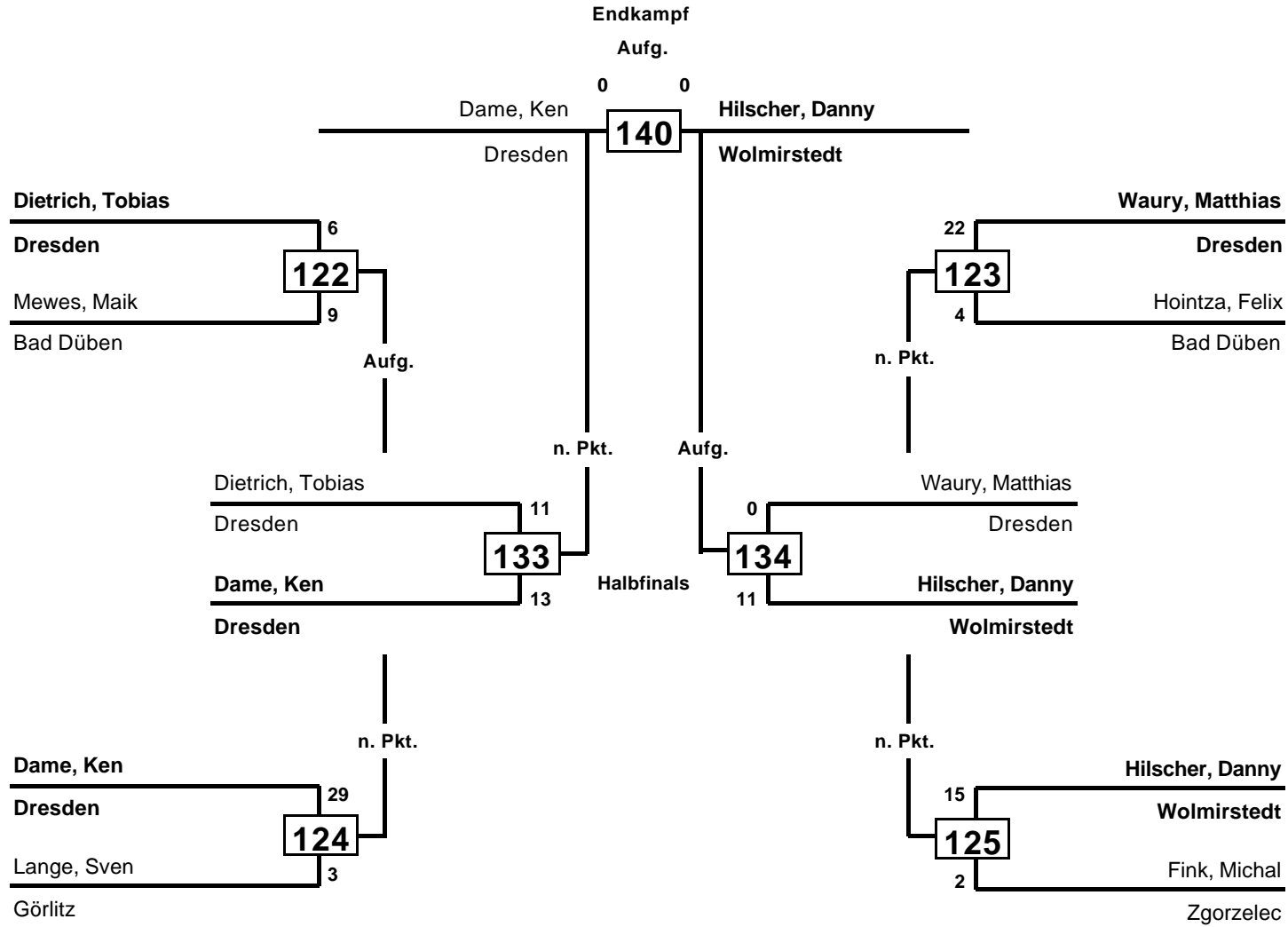

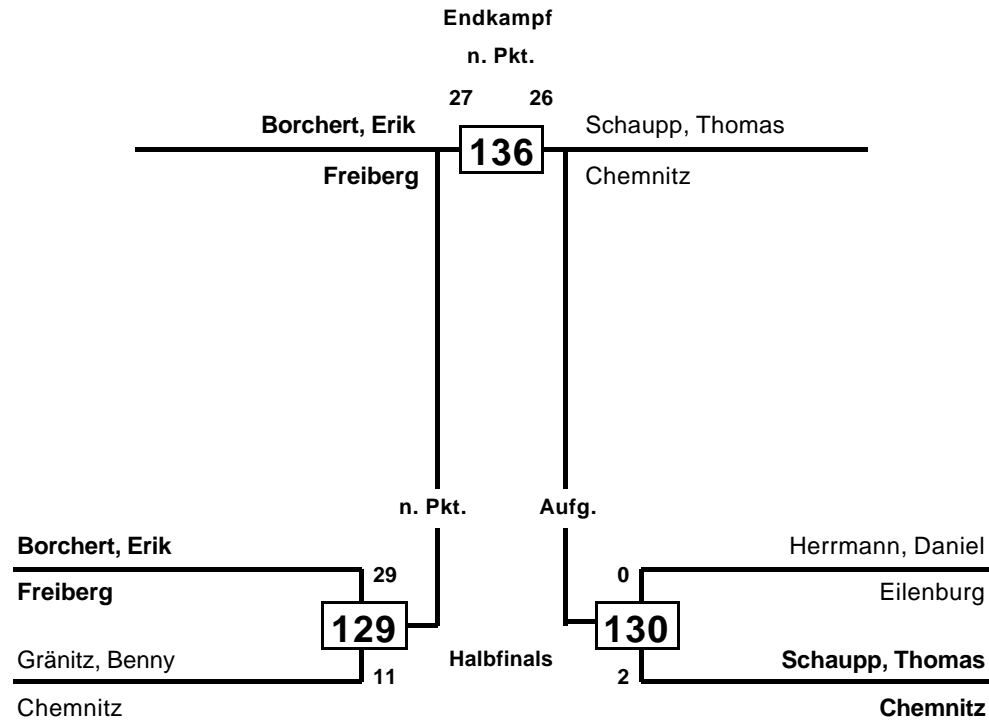

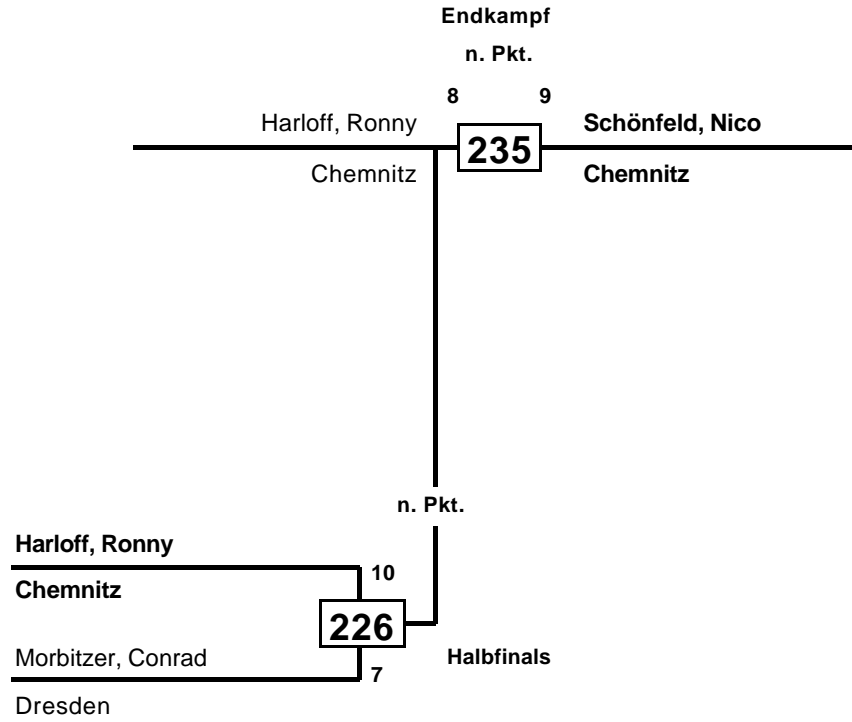

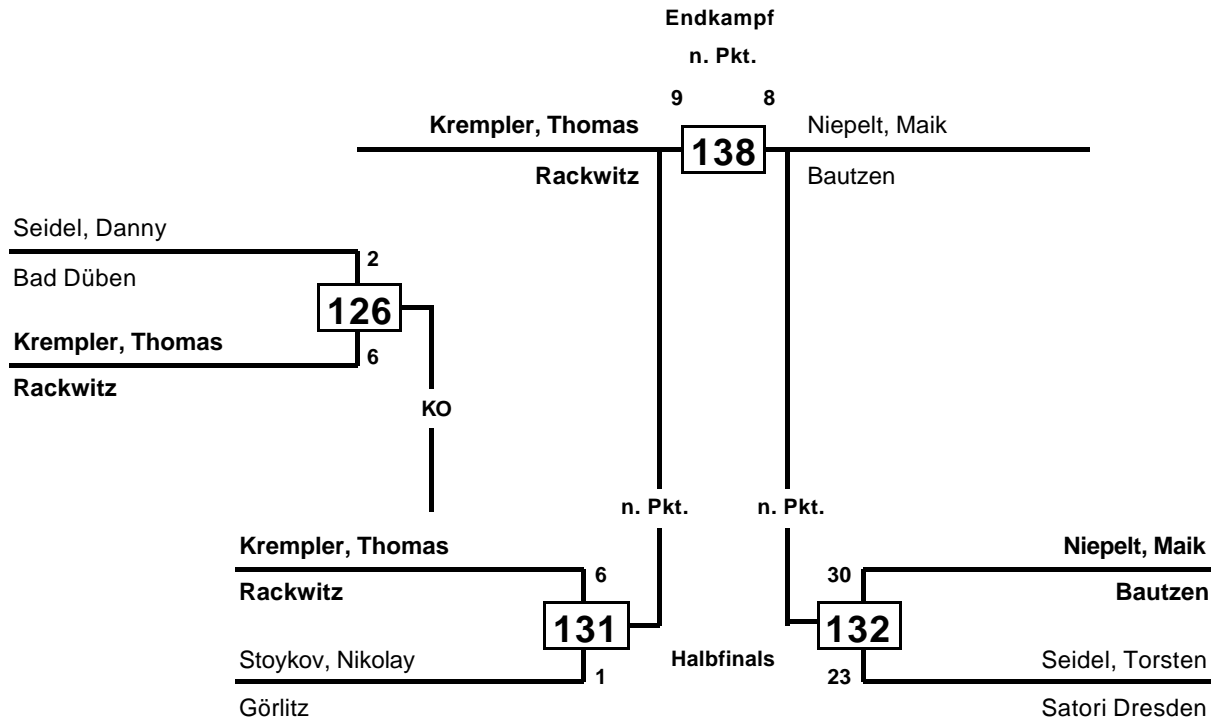



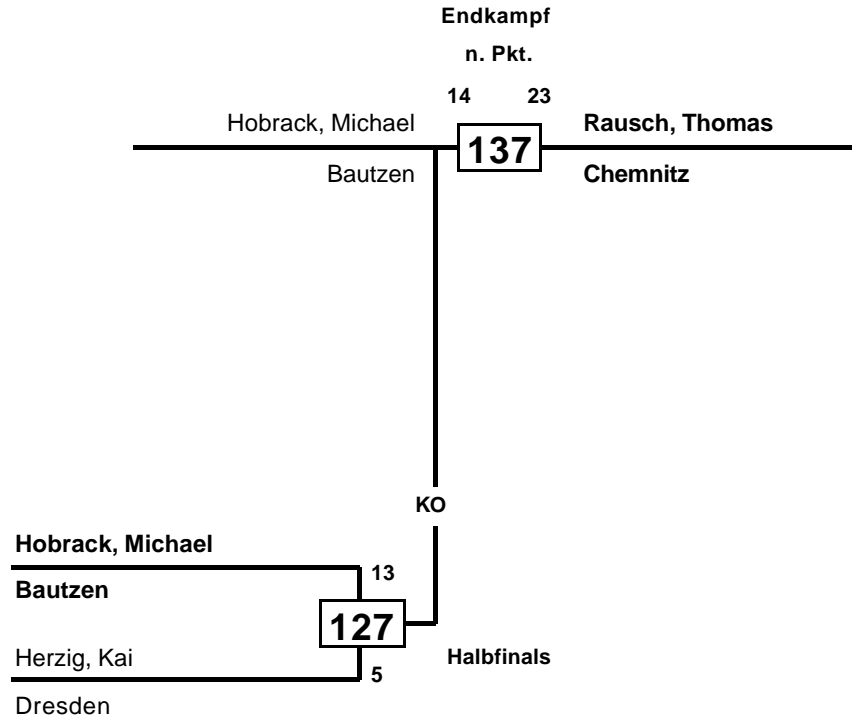

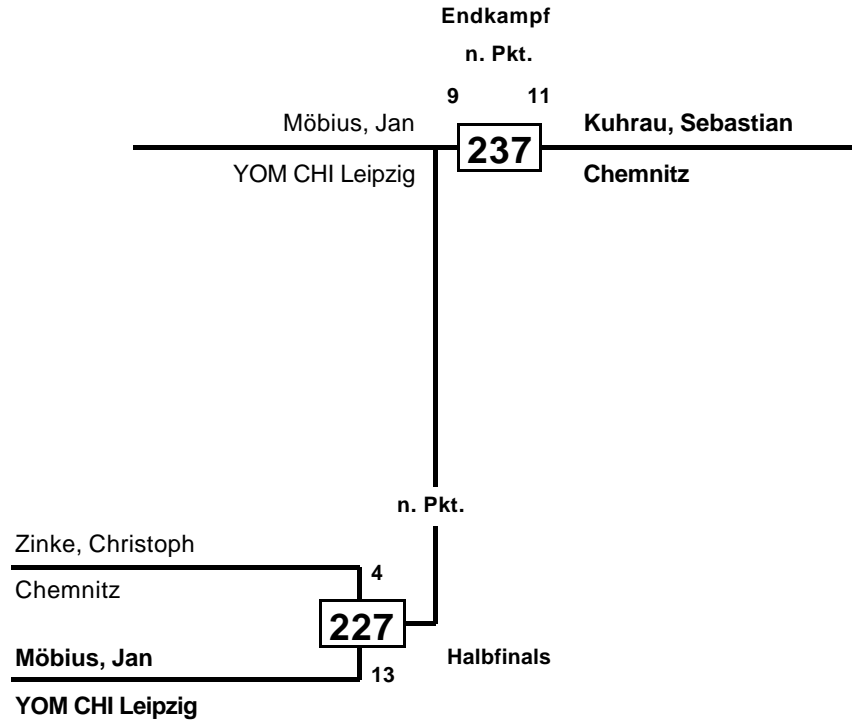

Endkampf

n. Pkt.

22 15

Dietel, Stephan

Meichsner, Bert

Freiberg

Zwönitz

236

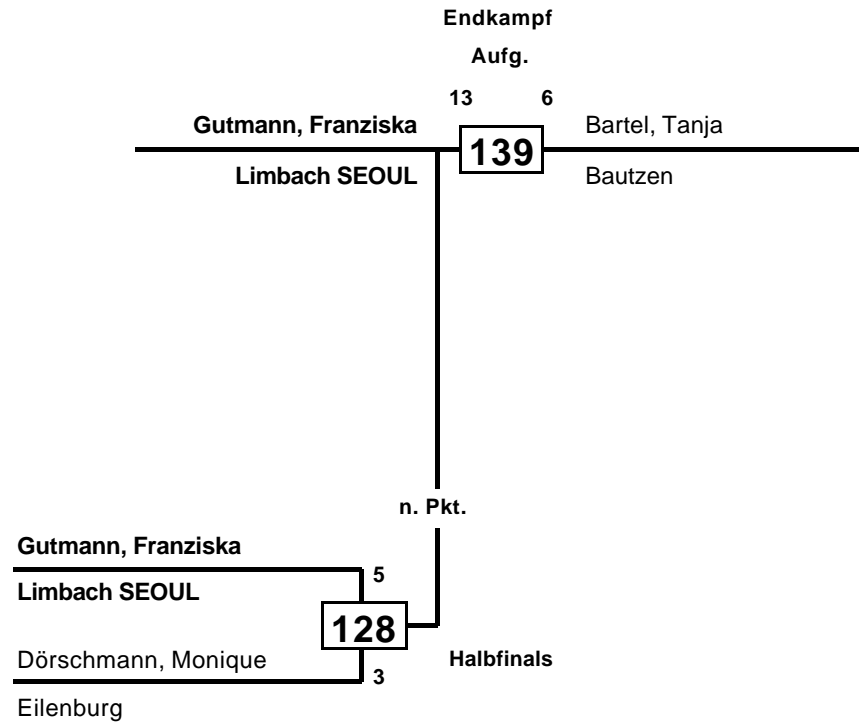

Endkampf

n. Pkt.

14 5

Höhnisch, Josephine

Mager, Stephanie

Zwönitz

Nickelhütte Aue

135

**D 72+**

**2** 8. Oberlausitz Cup

Radibor 25.03.06

**Pool Nr.: 1**

---

Endkampf

Aufg.

20 3

Schwarz, Jana

Mager, Nadin

Zwönitz

141

Nickelhütte Aue

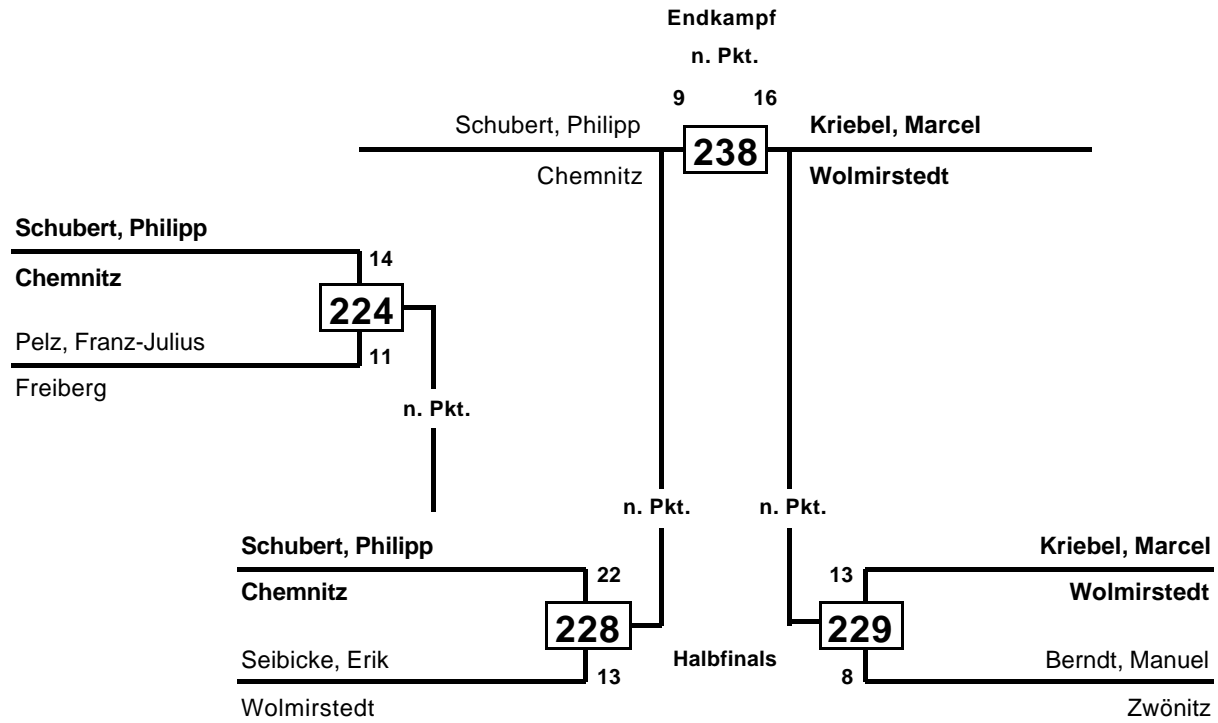

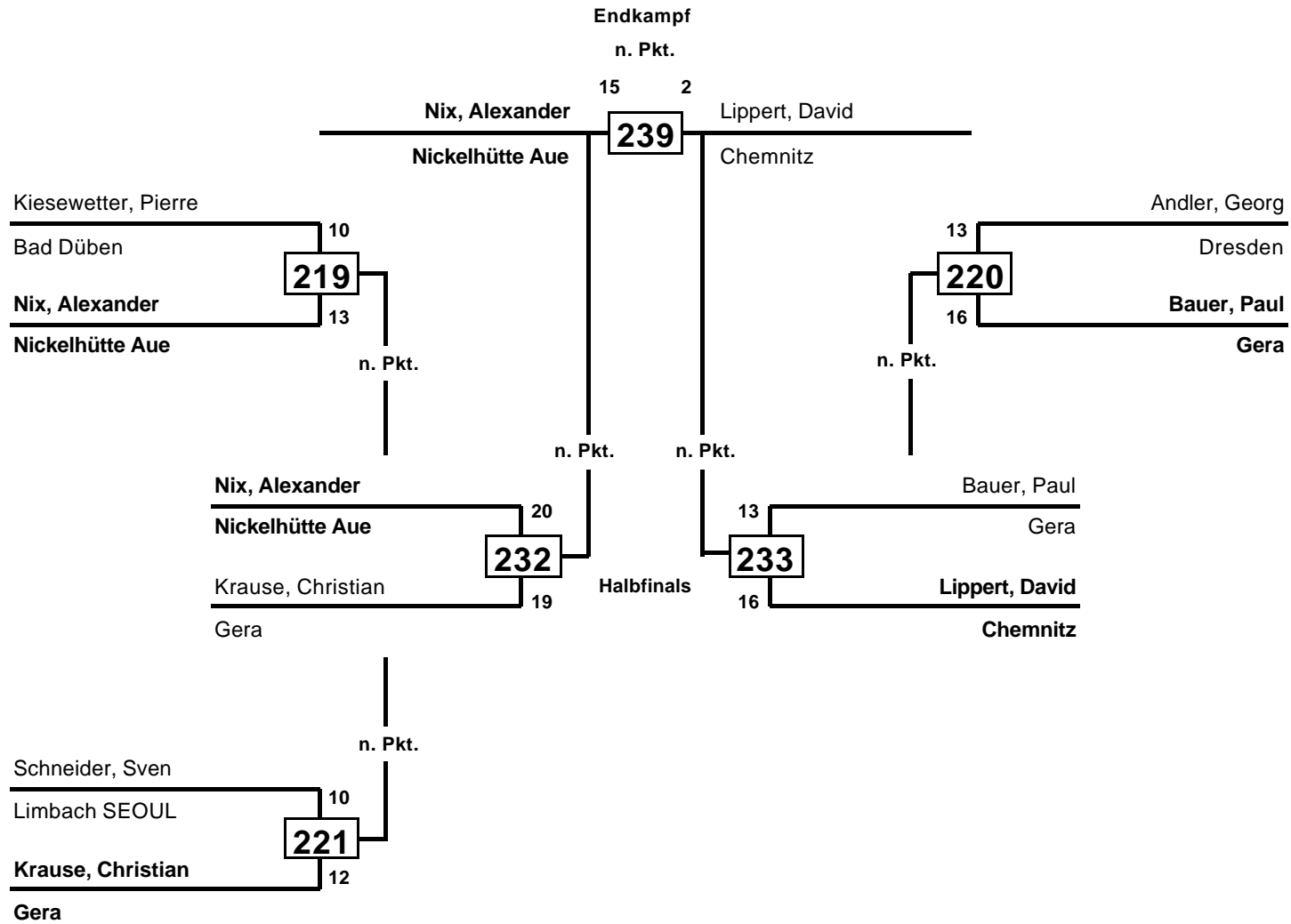



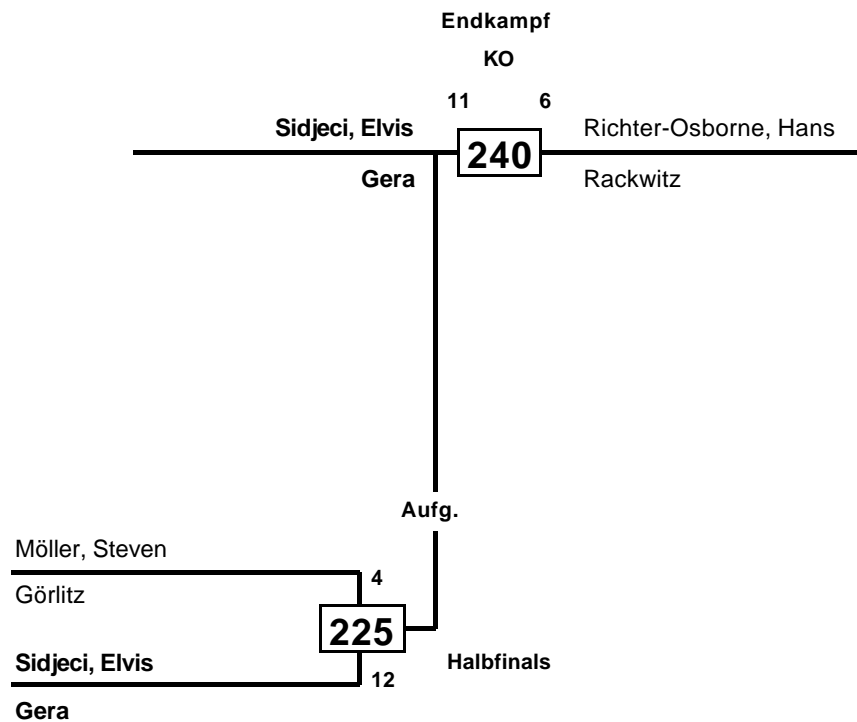

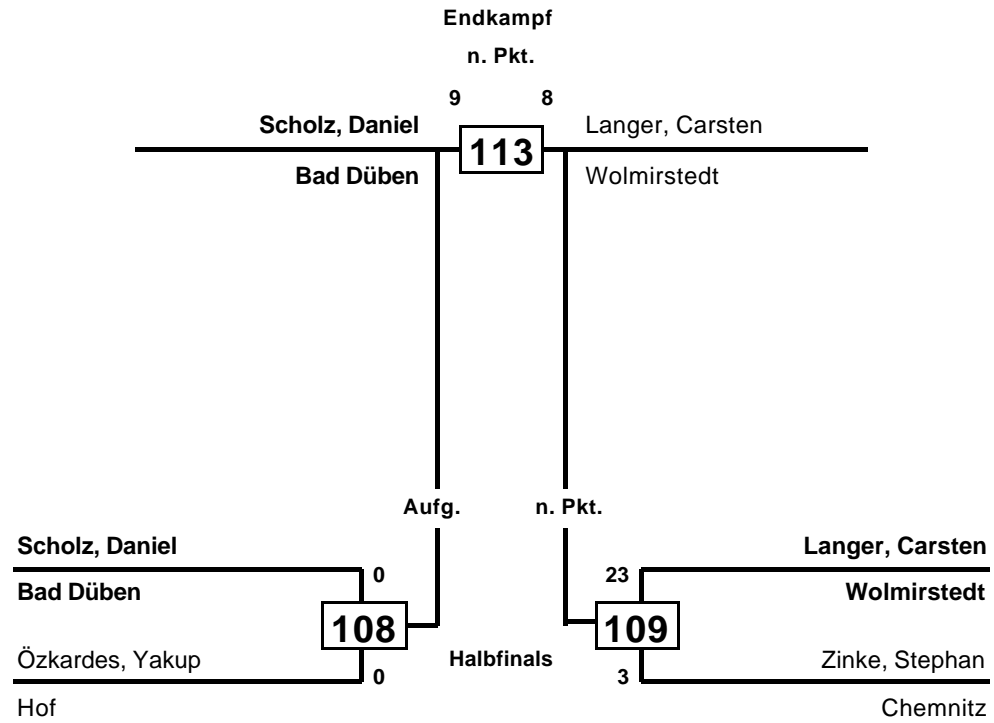

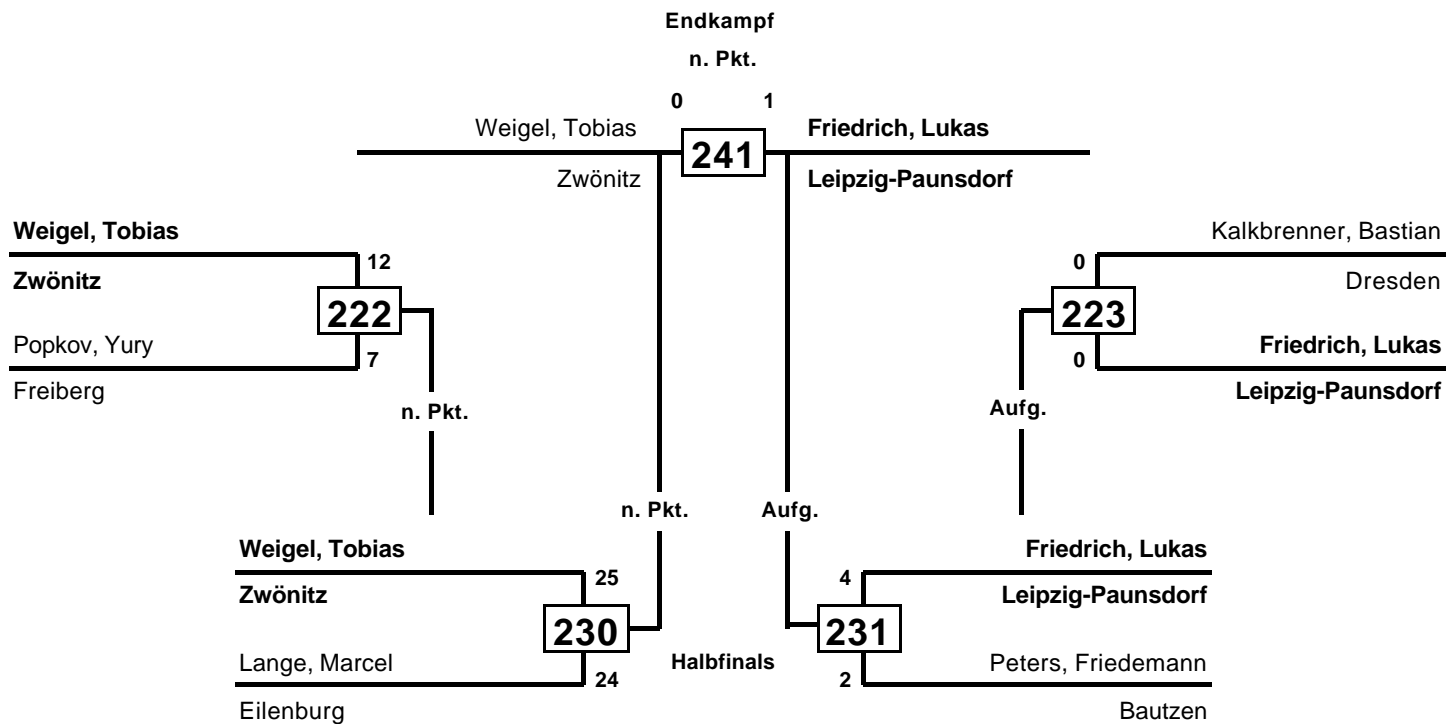

Endkampf

n. Pkt.

21 14

Kaygisiz, Ramazan

Liebald, René

Hof

**112**

Dresden

Endkampf	
n. Pkt.	
Schwarz, Anja	7
Striegnitz, Daniela	4
Zwönitz	<b>211</b>
Gera	

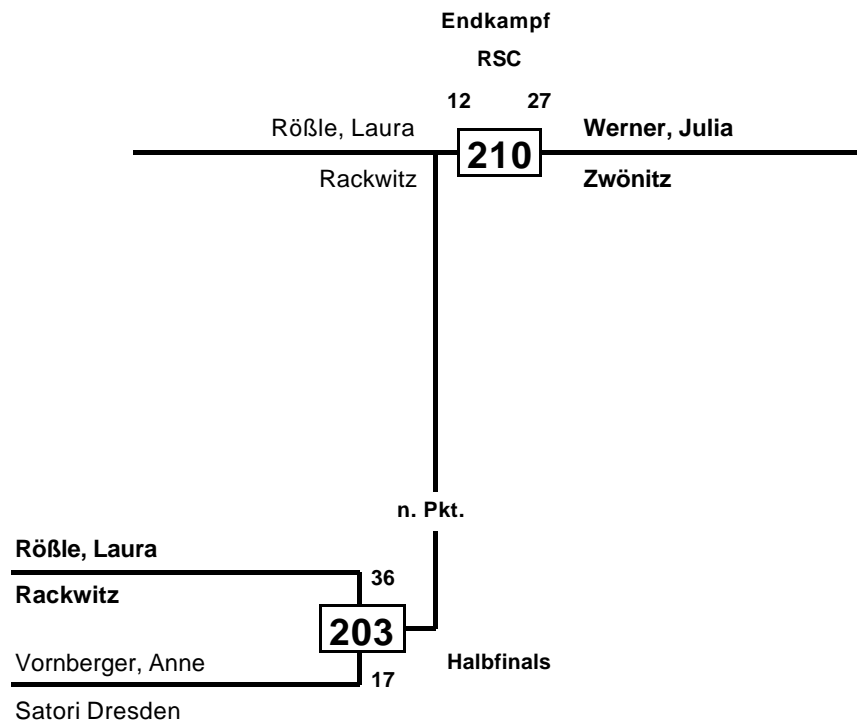

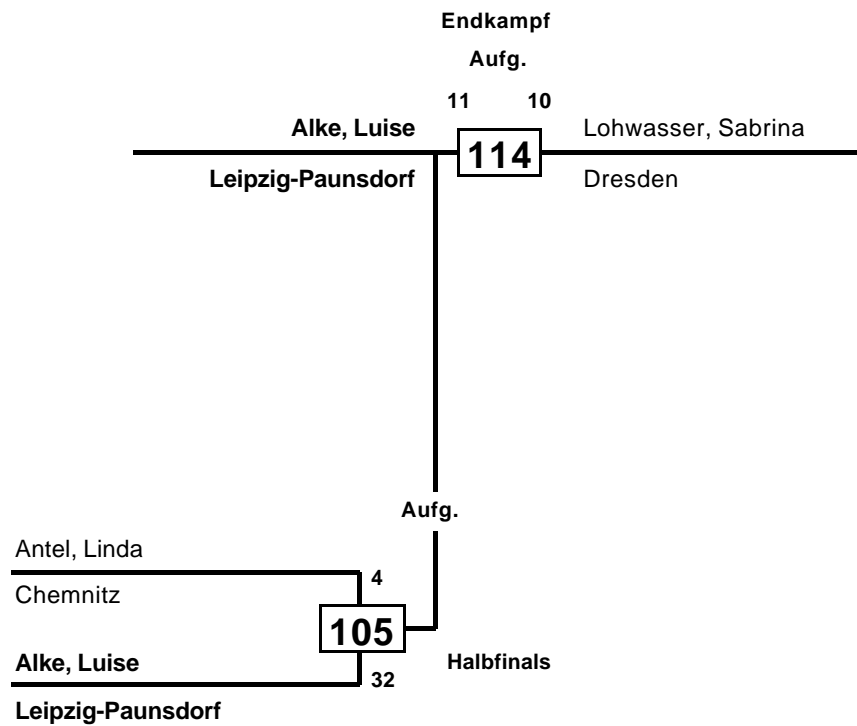

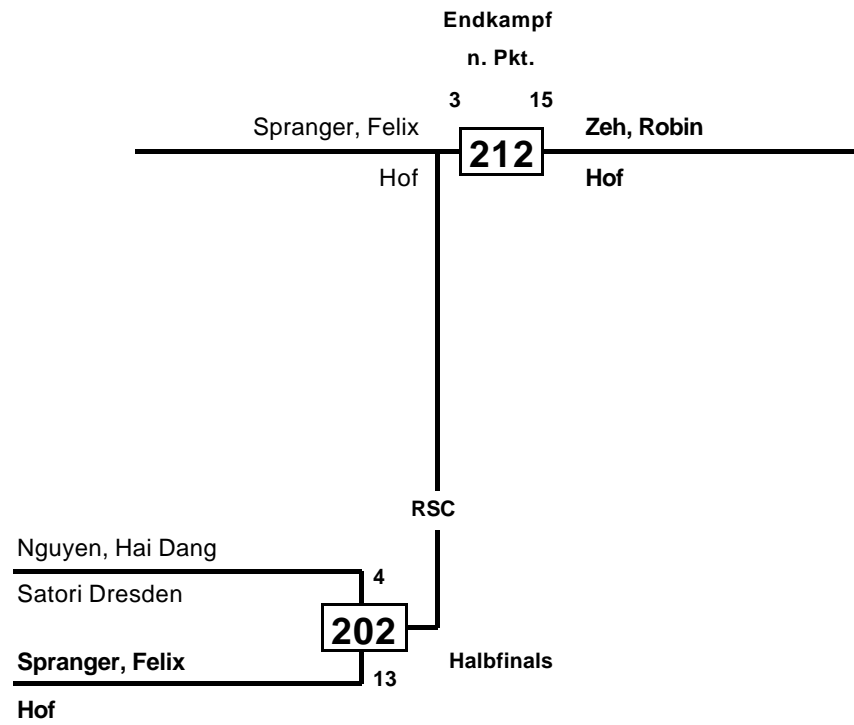



Endkampf

n. Pkt.

1 9

Gefrörer, Tim

Jensky, Martin

Rackwitz

Gera

**213**

Endkampf

n. Pkt.

6 13

Reinhold, Tino

Rehberg, Dominik

Bad Düben

Hof

**115**

Endkampf

n. Pkt.

15 18

Wils, Jeffrey

Röschke, Martin

Nickelhütte Aue

Bautzen

**116**

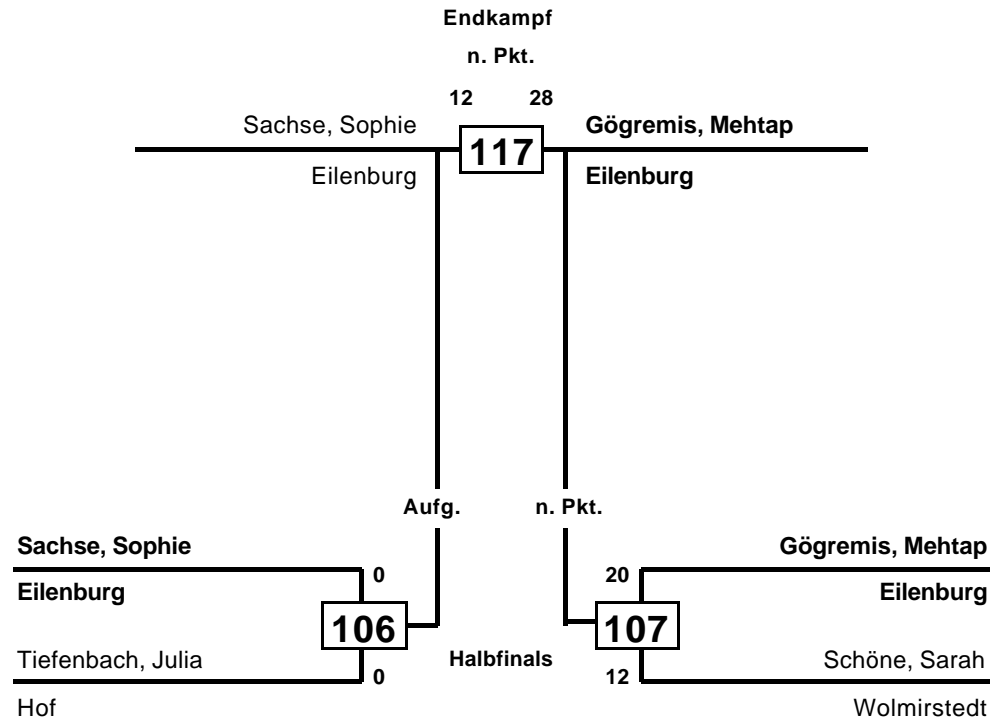

Endkampf	
n. Pkt.	
Heinzig, Sabrina	20 4
Eilenburg	<b>214</b>
Schwipper, Stephanie	
Eilenburg	

Endkampf

n. Pkt.

0 8

Ehrlich, Anna

Stimpel, Julia

Limbach SEOUL

Wolmirstedt

**216**

